

**HIGH VOLTAGE FAST-SWITCHING
NPN POWER TRANSISTOR**

- HIGH VOLTAGE CAPABILITY
- VERY HIGH SWITCHING SPEED
- LOW BASE-DRIVE REQUIREMENTS
- U.L. RECOGNISED ISOWATT218 PACKAGE (U.L. FILE # E81734 (N))

APPLICATIONS:

- SWITCH MODE POWER SUPPLIES
- HORIZONTAL DEFLECTION FOR COLOUR TVS AND MONITORS

DESCRIPTION

The SGSF465 and SGSIF465 are manufactured using Multi-epitaxial Mesa technology for cost-effective high performance and uses a Hollow Emitter structure to enhance switching speeds.

The SGSF series is designed for high speed switching applications such as power supplies and horizontal deflection circuits in TVs and monitors.

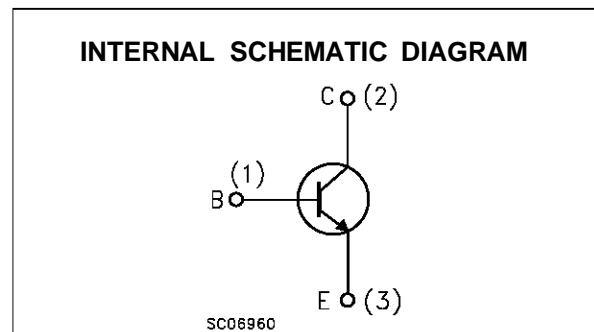
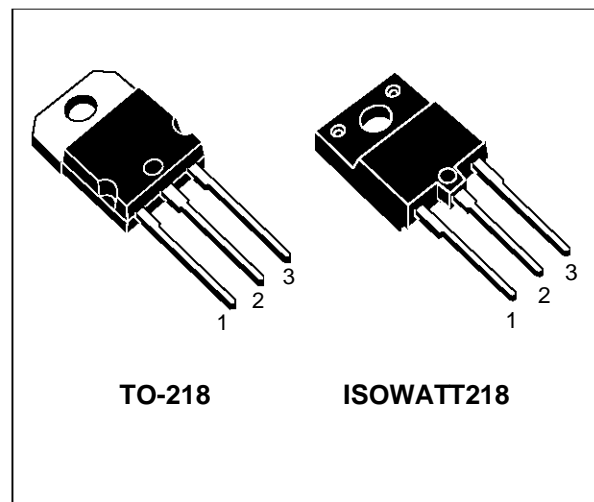

ABSOLUTE MAXIMUM RATINGS

Symbol	Parameter	Value	Unit	
V_{CES}	Collector-Emitter Voltage ($V_{BE} = 0$)	1300	V	
V_{CEO}	Collector-Emitter Voltage ($I_B = 0$)	600	V	
V_{EBO}	Emitter-Base Voltage ($I_C = 0$)	7	V	
I_C	Collector Current	10	A	
I_{CM}	Collector Peak Current ($t_p < 5$ ms)	15	A	
I_B	Base Current	7	A	
I_{BM}	Base Peak Current ($t_p < 5$ ms)	12	A	
P_{tot}	Total Dissipation at $T_c = 25$ °C	125	57	W
T_{stg}	Storage Temperature	-65 to 150 °C		
T_j	Max. Operating Junction Temperature	150 °C		

THERMAL DATA

			TO-218	ISOWATT218	
R _{thj-case}	Thermal Resistance Junction-Case	Max	1	2.2	°C/W
R _{thj-amb}	Thermal Resistance Junction-Ambient	Max	30		°C/W

ELECTRICAL CHARACTERISTICS (T_{case} = 25 °C unless otherwise specified)

Symbol	Parameter	Test Conditions	Min.	Typ.	Max.	Unit
I _{CES}	Collector Cut-off Current (V _{BE} = 0)	V _{CE} = 1300 V			200	μA
I _{CEO}	Collector Cut-off Current (I _B = 0)	V _{EC} = 380 V V _{EC} = 600 V			200 2	μA mA
I _{EBO}	Emitter Cut-off Current (I _C = 0)	V _{BE} = 7 V			1	mA
V _{CEO(sus)*}	Collector-Emitter Sustaining Voltage	I _C = 100 mA	600			V
V _{CE(sat)*}	Collector-Emitter Saturation Voltage	I _C = 5 A I _B = 1 A I _C = 3 A I _B = 0.4 A			1.5 1.5	V V
V _{BE(sat)*}	Base-Emitter Saturation Voltage	I _C = 5 A I _B = 1 A I _C = 3 A I _B = 0.4 A			1.5 1.5	V V
t _{ON} t _s t _f	Turn-on Time Storage Time Fall Time	RESISTIVE LOAD V _{CC} = 250 v I _C = 6 A I _{B1} = 1 A I _{B1} = -2 A		0.6 2.45 0.12	1.2 3.5 0.4	μs μs μs
t _{ON} t _s t _f	Turn-on Time Storage Time Fall Time	RESISTIVE LOAD V _{CC} = 250 v I _C = 5 A I _{B1} = 1 A I _{B1} = -2 A With Antisaturation Network		0.6 1.7 0.12		μs μs μs
t _{ON} t _s t _f	Turn-on Time Storage Time Fall Time	RESISTIVE LOAD V _{CC} = 250 V I _C = 5 A I _{B1} = 1 A V _{BE(off)} = - 5 V		0.6 1.3 0.2		μs μs μs
t _s t _f	Storage Time Fall Time	INDUCTIVE LOAD I _C = 5 A h _{FE} = 5 V _{CL} = 450 V V _{BE(off)} = -5 V L = 300 μH R _{BB} = 0.8 Ω		1.4 0.1	2.8 0.2	μs μs
t _s t _f	Storage Time Fall Time	INDUCTIVE LOAD I _C = 5 A h _{FE} = 5 V _{CL} = 450 V V _{BE(off)} = -5 V L = 300 μH R _{BB} = 0.8 Ω T _c = 100 °C			4 0.3	μs μs

* Pulsed: Pulse duration = 300 μs, duty cycle 1.5 %

Safe Operating Area Thermal Impedance

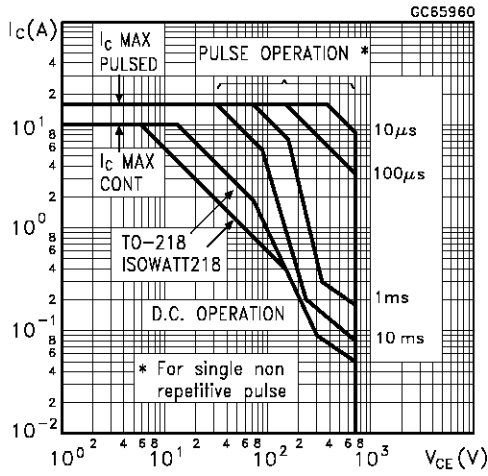

Derating Curve

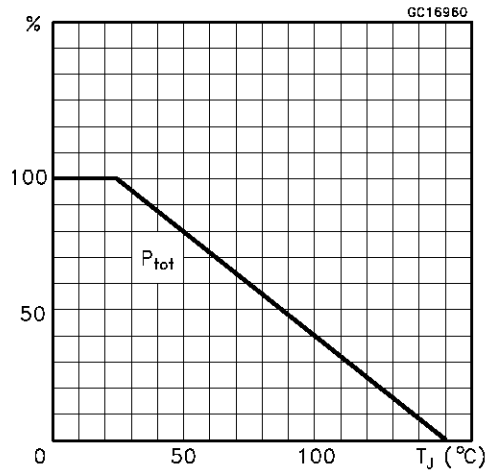

DC Current Gain

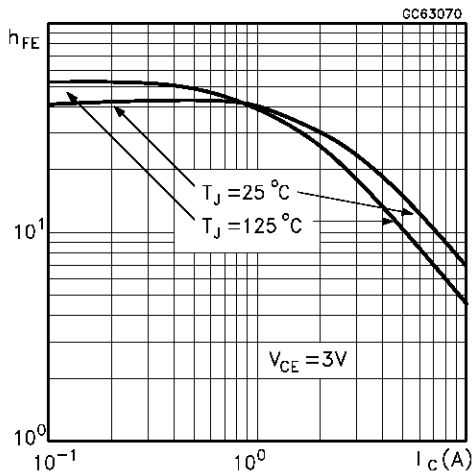

Collector Emitter Saturation Voltage

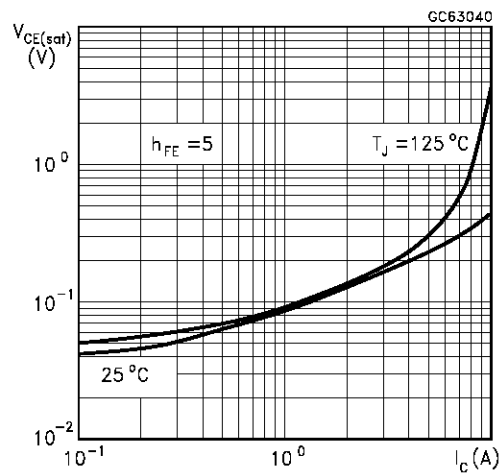

Base Emitter Saturation Voltage

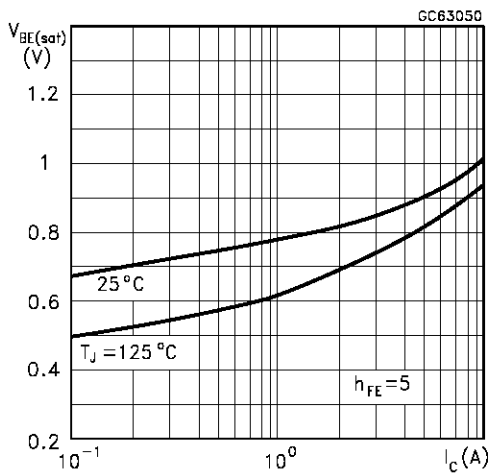

Reverse Biased SOA

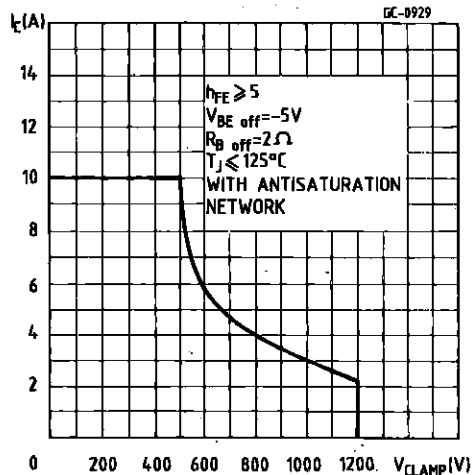

Resistive Load Switching Times

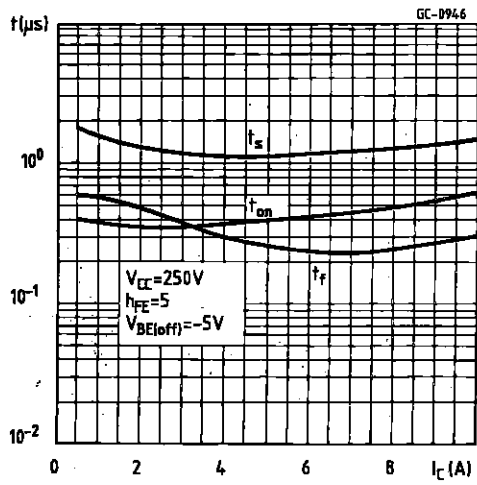

Resistive Load Switching Times

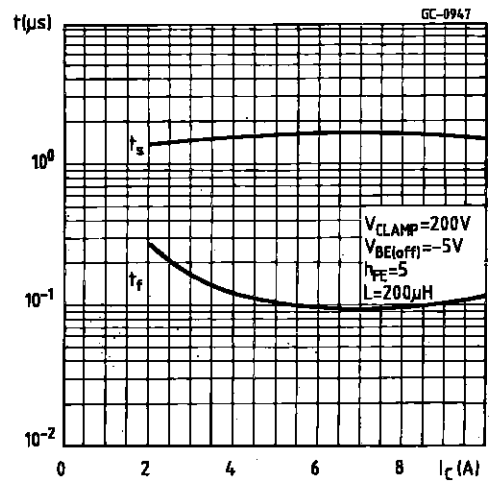

Switching Times Percentance Variation

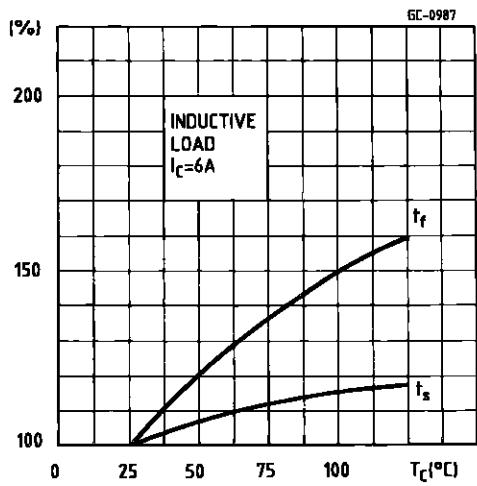

TO-218 (SOT-93) MECHANICAL DATA

DIM.	mm			inch		
	MIN.	TYP.	MAX.	MIN.	TYP.	MAX.
A	4.7		4.9	0.185		0.193
C	1.17		1.37	0.046		0.054
D		2.5			0.098	
E	0.5		0.78	0.019		0.030
F	1.1		1.3	0.043		0.051
G	10.8		11.1	0.425		0.437
H	14.7		15.2	0.578		0.598
L2	–		16.2	–		0.637
L3		18			0.708	
L5	3.95		4.15	0.155		0.163
L6		31			1.220	
R	–		12.2	–		0.480
Ø	4		4.1	0.157		0.161

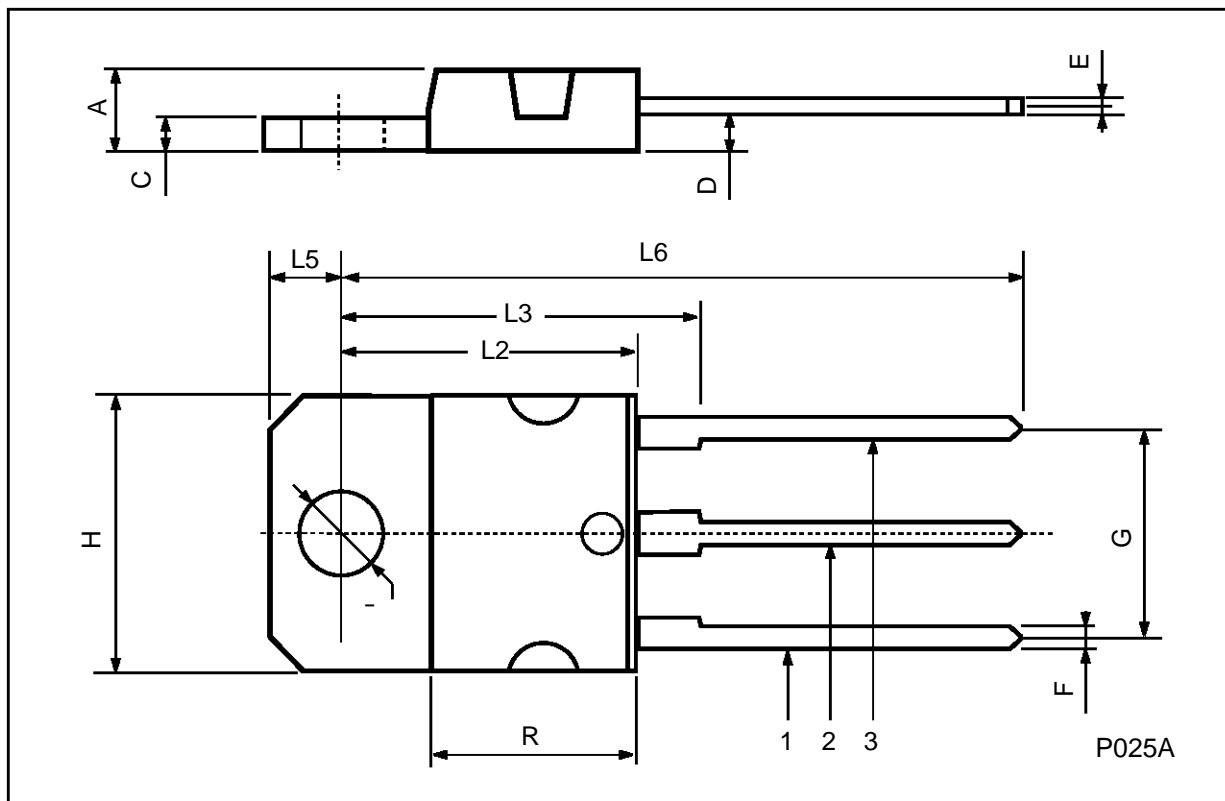

ISOWATT218 MECHANICAL DATA

DIM.	mm			inch		
	MIN.	TYP.	MAX.	MIN.	TYP.	MAX.
A	5.35		5.65	0.210		0.222
C	3.3		3.8	0.130		0.149
D	2.9		3.1	0.114		0.122
D1	1.88		2.08	0.074		0.081
E	0.75		1	0.029		0.039
F	1.05		1.25	0.041		0.049
G	10.8		11.2	0.425		0.441
H	15.8		16.2	0.622		0.637
L1	20.8		21.2	0.818		0.834
L2	19.1		19.9	0.752		0.783
L3	22.8		23.6	0.897		0.929
L4	40.5		42.5	1.594		1.673
L5	4.85		5.25	0.190		0.206
L6	20.25		20.75	0.797		0.817
M	3.5		3.7	0.137		0.145
N	2.1		2.3	0.082		0.090
U		4.6			0.181	

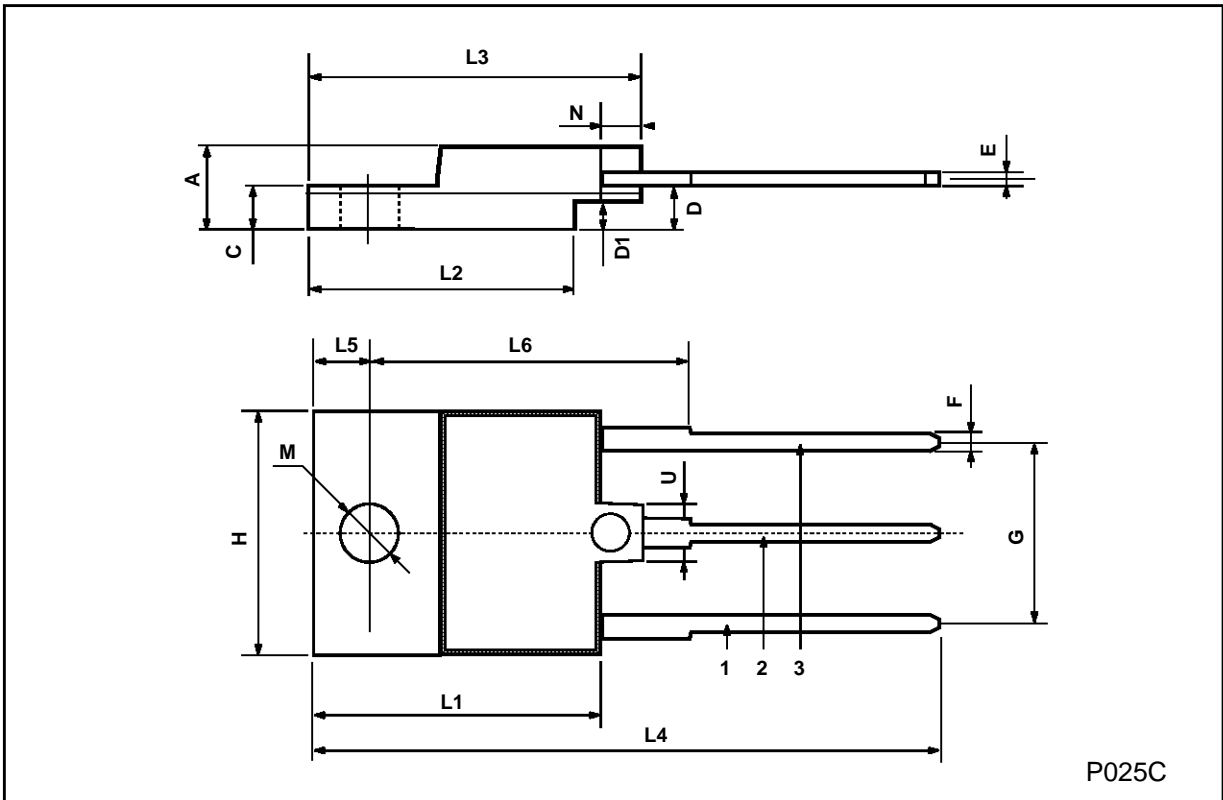

Information furnished is believed to be accurate and reliable. However, SGS-THOMSON Microelectronics assumes no responsibility for the consequences of use of such information nor for any infringement of patents or other rights of third parties which may result from its use. No license is granted by implication or otherwise under any patent or patent rights of SGS-THOMSON Microelectronics. Specifications mentioned in this publication are subject to change without notice. This publication supersedes and replaces all information previously supplied. SGS-THOMSON Microelectronics products are not authorized for use as critical components in life support devices or systems without express written approval of SGS-THOMSON Microelectronics.

© 1996 SGS-THOMSON Microelectronics - Printed in Italy - All Rights Reserved

SGS-THOMSON Microelectronics GROUP OF COMPANIES

Australia - Brazil - Canada - China - France - Germany - Hong Kong - Italy - Japan - Korea - Malaysia - Malta - Morocco - The Netherlands - Singapore - Spain - Sweden - Switzerland - Taiwan - Thailand - United Kingdom - U.S.A